

VALIDATION OF A SIMPLIFIED PV SIMULATION ENGINE

Richard Perez
ASRC, the University at Albany
251 Fuller Rd.
Albany, NY, 12203
Email: perez@asrc.cestm.albany.edu

Rebecca Reed
ASRC, the University at Albany
251 Fuller Rd.
Albany, NY, 12203

Thomas Hoff
Clean Power Research
10, Glen Court
Napa CA 94558
tomhoff@clean-power.com

ABSTRACT

We describe and validate a simple PV simulation model capable of predicting average PV output as a function of array geometry (slope & azimuth) and location. This simulation tool is used in the Clean Power Estimator [1]. Results show that the simplified model accurately captures array-geometry, seasonal and daily PV output variations when benchmarked against a standard PV simulation program.

1. THE CLEAN POWER ESTIMATOR

The Clean Power Estimator – CPE – is a web-based PV economic evaluation program available in the US and several countries [1]. One of the strengths of this program resides in its versatile economic evaluation engine that accesses and accounts for local utility rates and PV deployment incentives.

The program is also capable of letting users specify array size and geometry, and can provide on-the-spot answers to any selected configuration. We describe the calculation engine used for PV geometry and present evidence of its accuracy in relation to accepted simulation standards.

2. PV SIMULATION IN CPE

Traditional PV simulation programs such as TRNSYS [2], PVFORM [3] and its more recent derivatives (e.g., PV-

Watts [4], PV-DesignPro [5]) are based upon time series analysis. The input typically consists of one year worth of hourly global-direct irradiance, temperature and wind speed data (e.g., TMY data). Users may specify array geometry along with other PV and balance of system (BOS) parameters. The flow chart in Fig. 1 illustrates input and output flows in a program such as PVFORM.

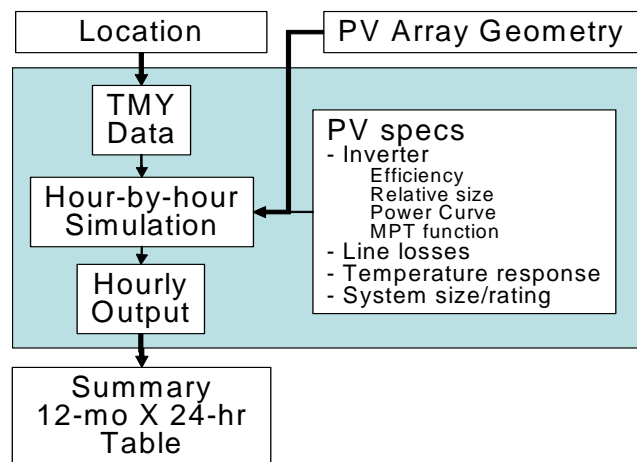

Fig.1: Input-output flowchart for time-series based PV simulations

Time series-based programs are versatile and adequate for many applications. However they may not be as appealing for web-based applications that put a premium on “instant gratification” implying high-speed of execution and/or data transfer. Web-based simulations can be performed either on

the host computer via applets, or on a centralized server. For host-based applications it is important to limit the amount of transferred data. Server-run applications do not have this limitation but may run the risk of overload if many users run the program at the same time. CPE can be run as either a host-based program on a centralized server.

Recognizing that average time-of-day and time-of year PV outputs are sufficient for most economic analyses, our objective was to avoid transferring full yearly data sets running full-year simulations. We developed an approach based upon two pre-calculated 12-months by 24-hours average PV output tables: one for a 30 degree south-facing array, $Q(h,m)$, and the other for a horizontal array, $Q_h(h,m)$. These reference tables are precalculated using PVFORM, and, therefore, include fixed nominal assumptions relative to PV and BOS specifics. Notably, operating PV module temperature and temperature response are built in the two reference tables. The user may specify system geometry and size. All other PV technical options are fixed. The flow chart in Fig. 2 illustrates the modeling approach used in CPE.

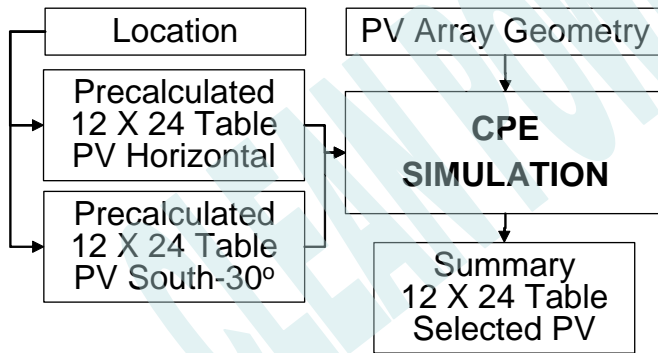

Fig.2: Input-output flowchart in CPE

The calculation of PV output on arbitrary surface proceeds as follows:

1. Removal of the ground-reflected component from the south-30 table: this is done by estimating reflected energy, $Q_r(h,m)$, from the horizontal reference table, $Q_h(h,m)$ using the same default albedo, alb , as in the PVFORM precalculations. Reflection-free energy is obtained from:

$$Q_r(h,m) = Q(h,m) - 0.67 alb Q_h(h,m)$$

2. Calculation of energy, $Q_d(h,m)$, resulting from quasi-direct irradiance impinging on the south-30 array.

$$Q_d(h,m) = Q_r(h,m) k(m) \cos(\theta(h,m))^{0.2}$$

Where $\theta(h,m)$ is the average monthly-hourly solar incidence angle on the south-30 array, and $k(m)$ is a site-dependent monthly factor representing the fraction of monthly average

global irradiance behaving directionally (i.e., direct and circumsolar irradiance).

3. Calculation of energy, $Q_i(h,m)$, resulting from quasi-isotropic irradiance impinging on the south-30 array. This is obtained from the difference of $Q_r(h,m)$ and $Q_d(h,m)$.

4. Calculation of energy, $Q_{dnew}(h,m)$, resulting from quasi-direct irradiance impinging on the selected array.
 $Q_{dnew}(h,m) = Q_d(h,m) \cos(\theta_{new}(h,m)) / \cos(\theta(h,m))$
 Where $\theta_{new}(h,m)$ is the hourly-monthly solar incidence angle on the new surface.

5. Calculation of energy, $Q_{inew}(h,m)$, resulting from quasi-isotropic irradiance impinging on the new array.

$$Q_{inew}(h,m) = Q_i(h,m) (1 + \cos(S_{new})) / 1.87$$

Where S_{new} is the slope of the selected PV array.

6. Calculation of reflected energy, $Q_{rnew}(h,m)$ on the selected array.

$$Q_{rnew}(h,m) = 0.5 (1 - \cos(S_{new})) alb Q_h(h,m)$$

7. Calculation of the PV energy produced by the selected array

$$PV_{new}(h,m) = Q_{dnew}(h,m) + Q_{inew}(h,m) + Q_{rnew}(h,m)$$

3. VALIDATION

We selected a set of climatically distinct TMY locations – Albuquerque, NM, Albany, NY, Austin TX, Miami, FL, Phoenix, AZ and Seattle, WA -- and compared results obtained via PVFORM and CPE simulations.

3.1 Array Geometry Effects

In Fig. 3, we compare the total energy generated by a south-facing array in each location as a function of its slope. Note that, by definition of the CPE algorithm, PVFORM-derived results and CPE results are identical at 30 degree south. Results are presented in relative terms, normalized to 30 degree south.

The comparative performance for off-south orientations is presented for a subset of the sites (Albany and Albuquerque) in Fig. 4 (Southeast-facing arrays) and Fig. 5 (East-facing arrays).

Table I reports the all-sites average difference in Wm^{-2} for all slopes and orientations [including north facing]

From these results it is apparent that CPE does a good job at capturing all possible geometry configurations. South and near south-facing differences average less than $1.5 Wm^{-2}$. The largest departure -- still remarkable at $\sim 9 Wm^{-2}$ -- is found for the vertical north facing array. This is a non-issue for PV calculations, but note that the likely cause for this north departure has less to do with irradiance calculations than with the fact that the CPE relies on the module

temperatures of the two (warmer) reference arrays for all orientations.

3.2 Seasonal and Daily Variations

For two of the five stations (Albany and Phoenix) we illustrate the CPE capability to capture seasonal and daily

4. CONCLUSION

We have benchmarked the array-geometry calculation engine of the Clean Power Estimator against a validated standard, PVFORM [6] and we have shown, that despite the simplifying assumptions and compact calculation approach used in the CPE, the results are remarkably comparable.

This exercise indicates that web-based CPE simulations have a sound physical basis.

5. ACKNOWLEDGEMENT

The tilted irradiance engine of CPE was developed under funding from NYSERDA

6. REFERENCE

- (1) Hoff, T. E. (1999): Clean Power Estimator. ASES-1999 Conference, Portland, Worldwide version of the CPE may be found at <http://www.bpsolar.com>
- (2) Balcomb J.D., S.J. Hayter and N.L. Weaver (2001): Energy-10 PV: Photovoltaics, a New Capability. NREL/CP-550-29637
- (3) Menicucci D.F., and J.P. Fernandez, (1988): User's Manual for PVFORM. Report # SAND85-0376-UC-276, Sandia Natl. Labs, Albuquerque, NM
- (4) Marion B. et al. (1999-), PVWatts, a Performance Calculator for Grid-Connected PV Systems. http://rredc.nrel.gov/solar/codes_algs/PVWATTS/
- (5) PV-DesignPro (1999-): <http://www.mausolarsoftware.com/>
- (6) R. Perez, R., J. Doty and B. Bailey, (1994): Experimental Evaluation of a Photovoltaic Simulation Program. Solar Energy 52, 4, pp. 359-365

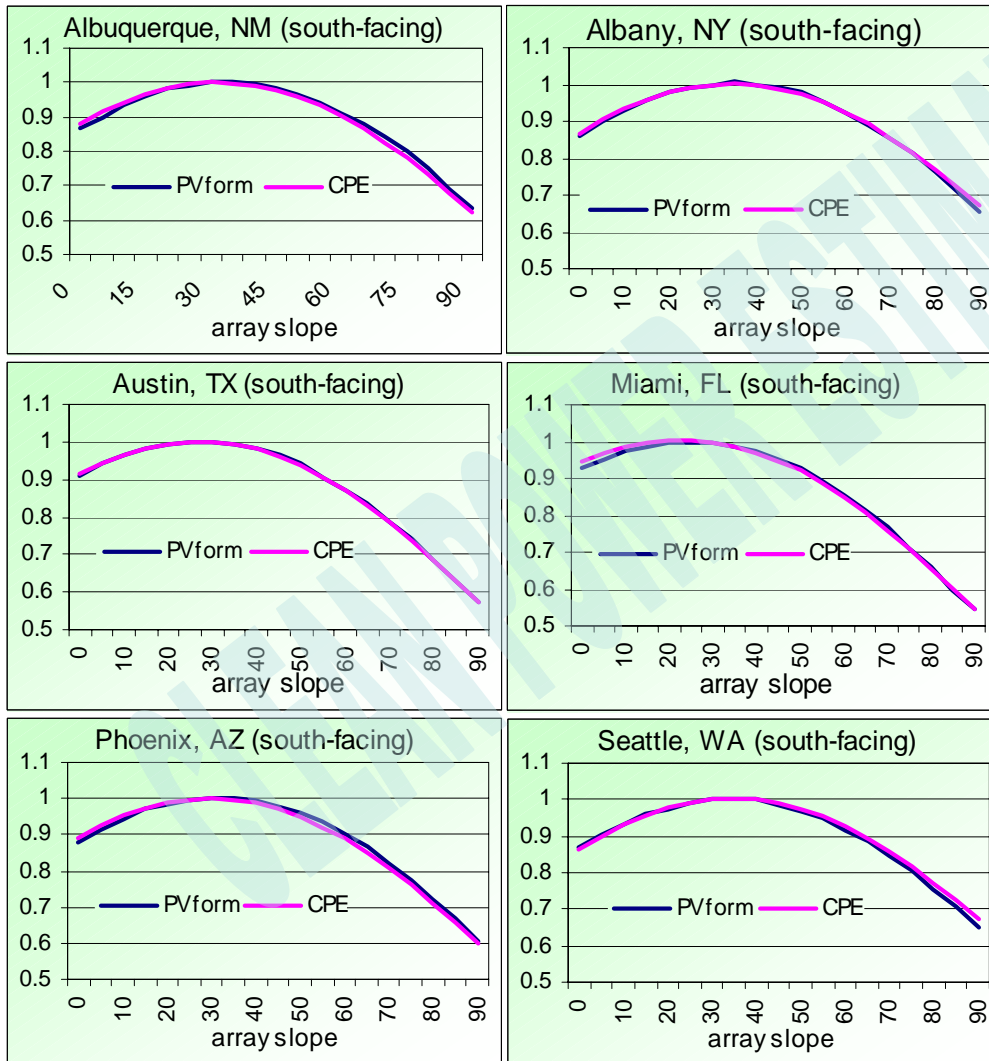

Fig. 3: Comparing PVFORM and CPE yearly energy generation for a south facing array as a function of its slope – all results are normalized with respect to a south-30° array.

output variations for two test orientations, south-45° and southwest-45°.

Through these graphs, it is apparent that the CPE captures the seasonal and daily variations which are essential for proper economic evaluations.

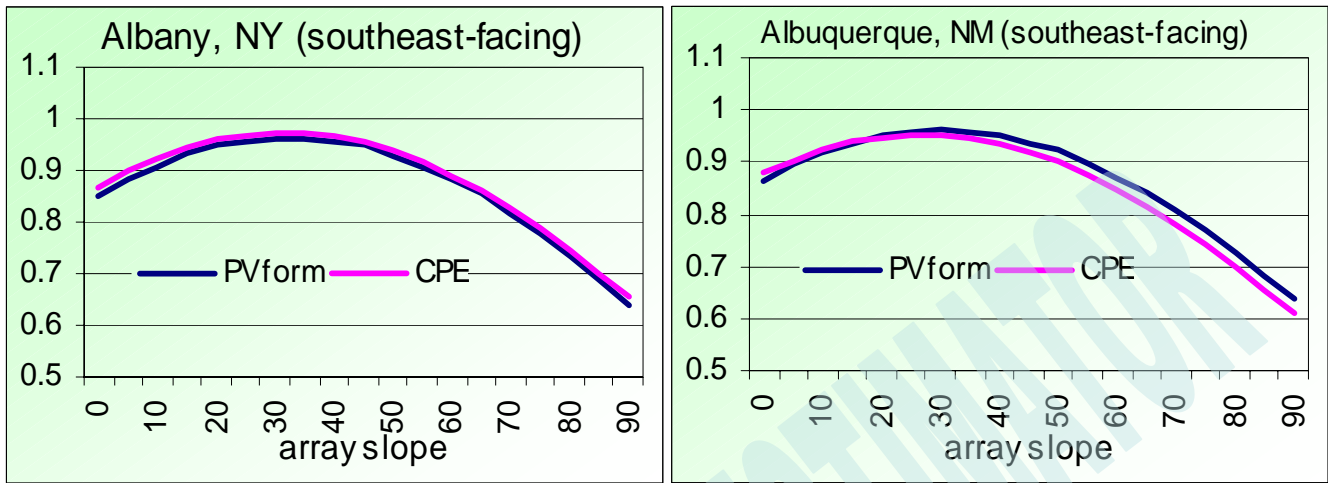

Fig.4: Comparing PVFORM and CPE yearly energy generation for a south-east facing array as a function of its slope – all results are normalized with respect to a sout-30° array.

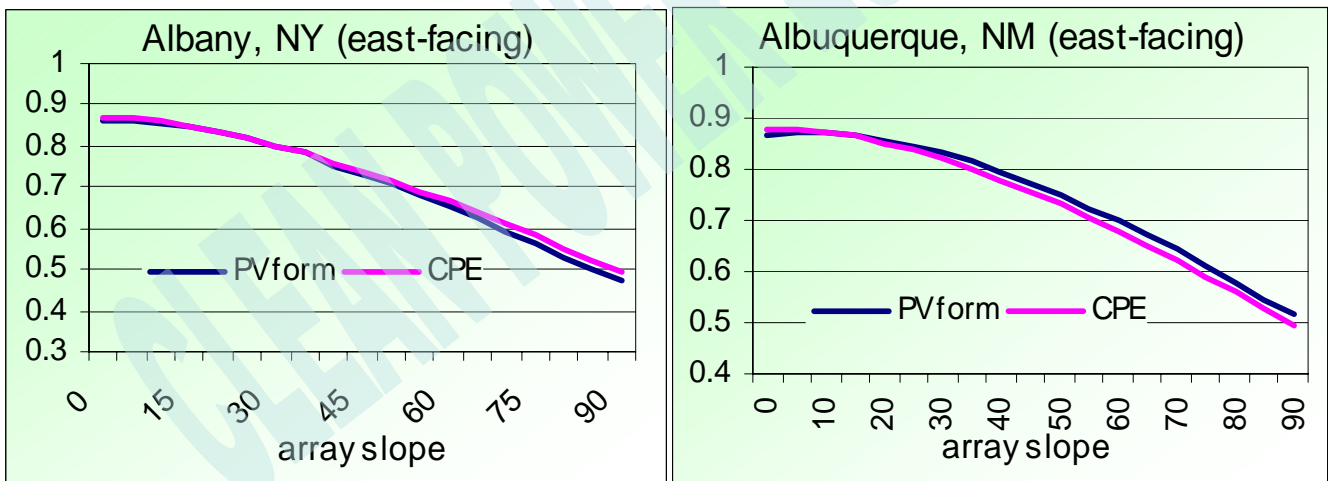

Fig.5: Comparing PVFORM and CPE yearly energy generation for an east facing array as a function of its slope – all results are normalized with respect to a sout-30° array.

TABLE 1

All-site average absolute difference between the yearly production of a nominal 1 kW PV system calculated by PVFORM and CPE (Whm²/year)

slope	----- Orientation -----							
	South	SE	East	SW	West	NE	NW	North
0	2.1	2.1	2.1	2.1	2.1	2.1	2.1	2.1
5	1.7	1.9	1.4	1.9	1.8	1.9	2.7	2.7
10	1.3	1.4	0.7	1.4	1.5	1.6	2.6	2.8
15	1.0	0.8	0.3	1.4	1.6	1.2	2.6	2.7
20	0.5	0.6	0.3	0.9	1.6	0.5	2.6	2.5
25	0.5	0.7	0.6	1.1	1.5	0.5	2.8	2.9
30	0.0	1.1	0.9	1.1	1.5	0.5	3.2	3.3
35	0.4	1.4	1.2	1.3	1.5	0.8	3.5	3.8
40	0.7	1.7	1.4	1.3	1.7	1.1	3.7	4.8
45	0.9	1.6	1.5	1.3	1.9	1.5	3.8	5.5
50	1.4	2.3	1.5	1.3	2.0	1.6	4.2	6.0
55	1.2	2.6	2.0	1.5	2.1	2.6	4.7	6.8
60	1.5	2.3	2.2	1.4	1.9	2.5	4.9	7.2
65	1.7	2.4	2.2	1.2	2.1	3.3	5.6	7.8
70	1.7	2.6	2.6	1.4	2.3	3.2	5.9	8.2
75	1.9	2.9	2.6	1.5	2.2	3.4	6.0	8.5
80	2.0	3.0	2.8	1.3	2.4	3.5	6.2	8.9
85	1.8	2.9	2.7	2.0	2.5	3.7	5.9	8.7
90	1.8	3.1	3.0	1.9	2.4	4.2	6.1	8.7

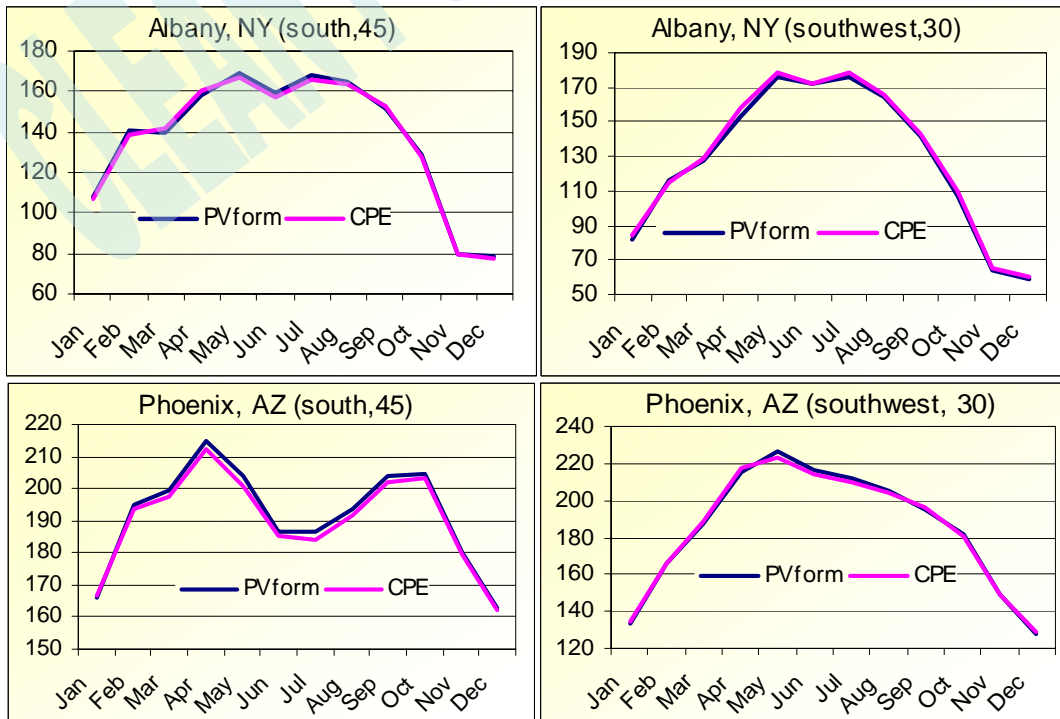

Fig. 6: Comparing the monthly output of two PV arrays in two locations As calculated by PVFORM and by CPE

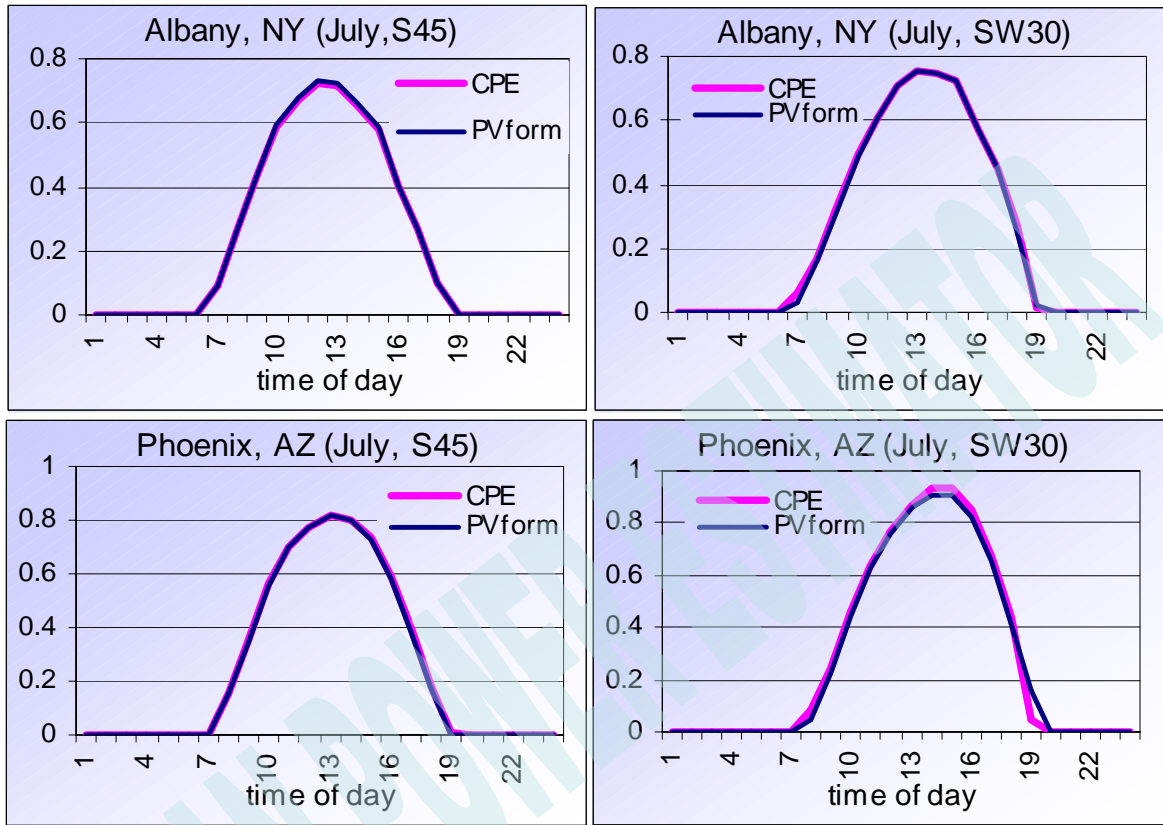

Fig. 7: Comparing the average daily output profiles of two PV arrays in two locations
As calculated by PVFORM and by CPE